

General Feature

- Absorbent Glass Mat(AGM) technology for efficient gas recombination of up to 99% and freedom from electrolyte maintenance or water adding.
- Not restricted for air transport-complies with IATA/ICAO Special Provision A67.
- UL-recognized component.
- Can be mounted in any orientation.
- Computer designed lead, calcium tin alloy grid for high power density.
- Long service life, float or cyclic applications.
- Maintenance-free operation.
- Low self discharge.

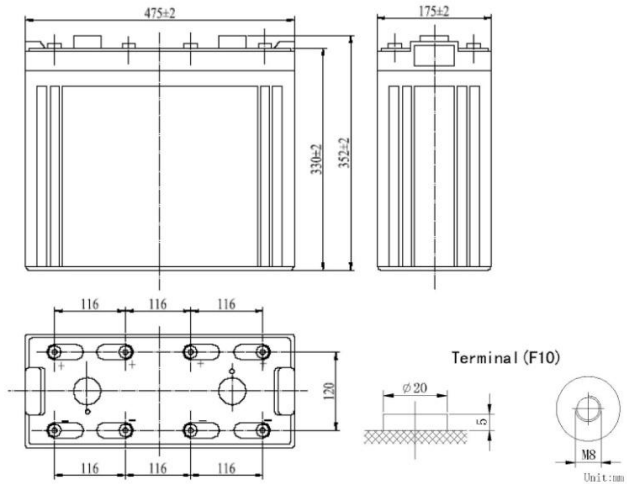

Total height with removable cover:367

SPECIFICATION

Nominal voltage	2V
Number of cell	1
Length(mm/inch)	475/18.7
Width(mm/inch)	175/6.89
Height(mm/inch)	330/13.0
Total Height(mm/inch)	367/14.45
Approx.Weight(kg/lbs)	71/156.5

Battery Construction

Component	Positive plate	Negative plate	Container	Cover	Safety valve	Terminal	Separator	Electrolyte
Raw material	Lead dioxide	Lead	ABS	ABS	Rubber	Copper	Fiberglass	Sulfuric acid

Performance Characteristics

Capacity 77°F(25°C)	10 hours rate(120A 1.80V)	1200Ah
	5 hours rate(208A 1.75V)	1040Ah
	3 hours rate(305A 1.70V)	915Ah
	1 hour rate(735A 1.60V)	735Ah
Internal Resistance	Full charged battery 77°F(25°C):0.5mΩ	
Capacity affected by Temperature (10 hour rate)	104°F(40°C)	102%
	77°F(25°C)	100%
	32°F(10°C)	85%
	5°F(-15°C)	65%
Self-Discharge 68°F(20°C)	Capacity after 3 month storage	90%
	Capacity after 6 month storage	80%
	Capacity after 12 month storage	60%
Max discharge current77°F(25°C):3000A(5S)		
Charge (Constant Voltage)	Float:2.25 to 2.30V/77°F/(25°C)	
	Cycle:2.35 to 2.45V/77°F/(25°C) Max Current:240A	

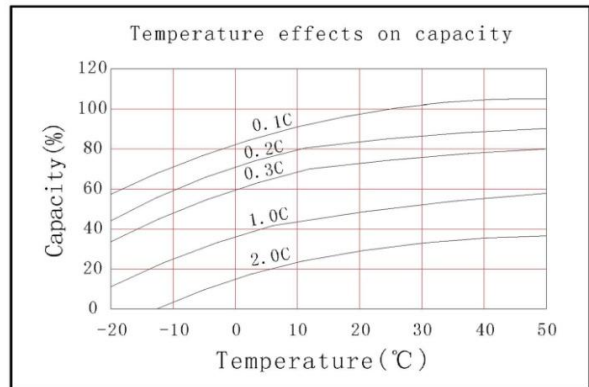
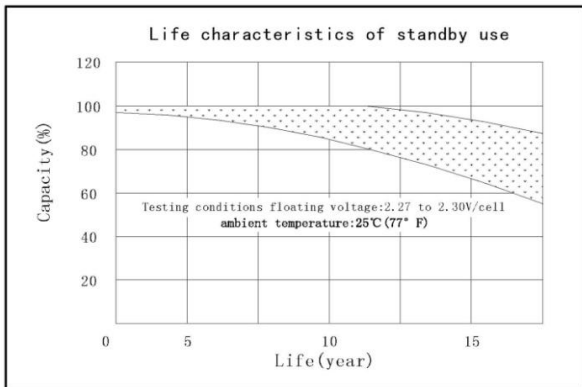
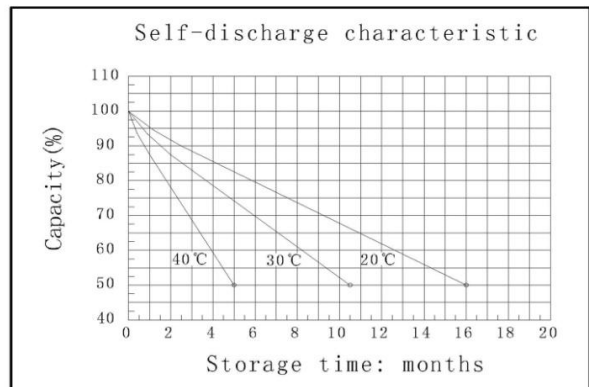
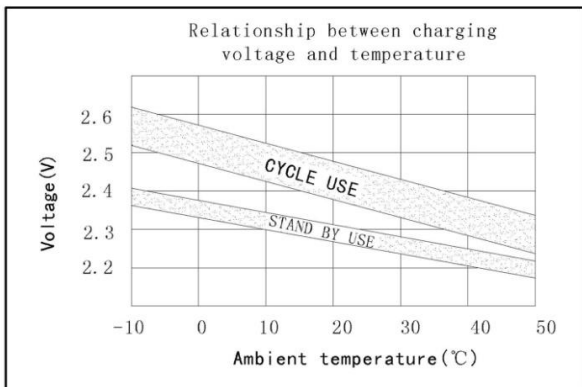
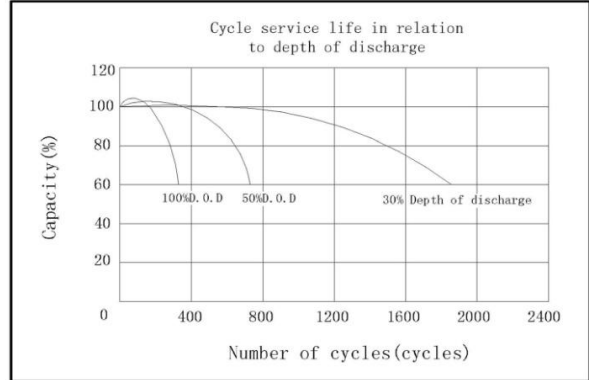
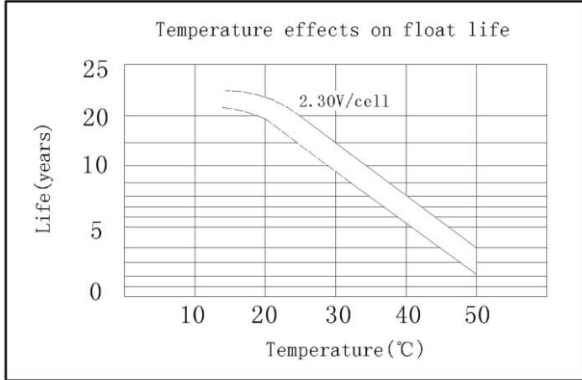
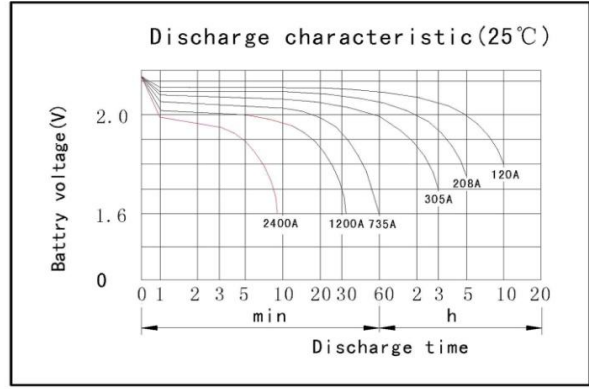
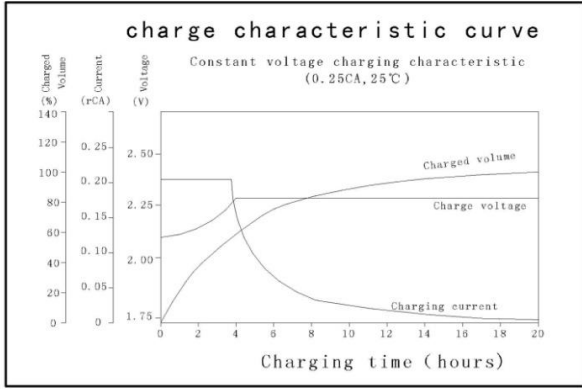

Discharge Constant Current (Amperes at 77° F 25 °C)

End Point Volts/Cell	5min	10min	15min	30min	45min	1h	3h	5h	10h
1.60V		2220	1685	1270	905	735	316	222	127
1.65V		2120	1635	1245	885	720	311	218	126
1.70V		2020	1585	1220	865	705	305	213	124
1.75V		1920	1535	1195	845	690	299	208	122
1.80V		1800	1475	1165	820	670	292	202	120

(Note) The above characteristics data are average values obtained Within three charge/discharge cycles not the minimum values.

Discharge Constant Power (watts at 77° F 25 °C)

End Point Volts/Cell	5min	10min	15min	30min	45min	1h	2h	3h	5h
1.60V		3409	2784	2075	1564	1281	828	600	414
1.65V		3212	2633	1970	1493	1227	807	583	407
1.70V		3013	2482	1864	1418	1170	791	572	400
1.75V		2814	2328	1756	1341	1112	777	561	392
1.80V		2617	2174	1647	1264	1052	760	547	385

(Note) The above characteristics data are average values obtained Within three charge/discharge cycles not the minimum values.